

DETAIL A
SCALE 4:1

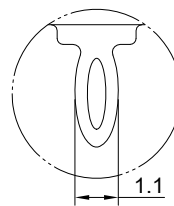

DETAIL B
SCALE 4:1

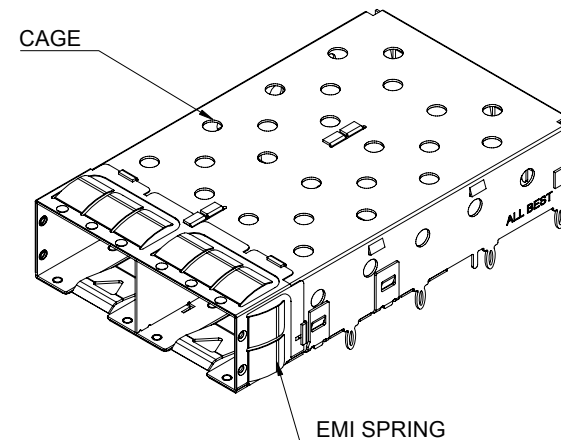

MATERIAL
CAGE: NICKEL SILVER
EMI SPRING: STAINLESS STEEL

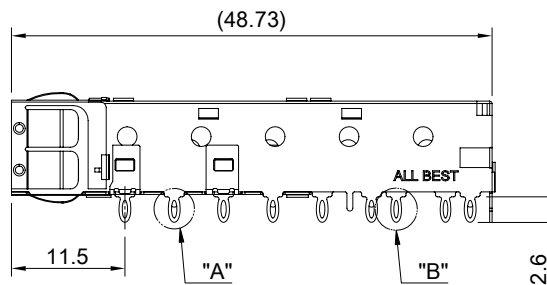
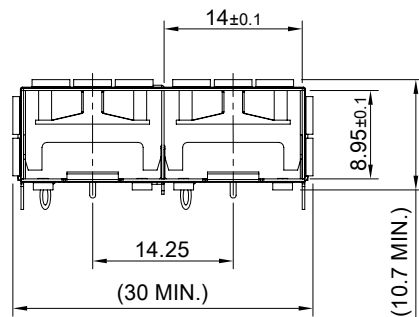

	TITLE: SFP+ 1X2 Cage Assembly		SHEET: 1/4	REV. D
	DWG#: R-SH-008040-6-F-19		CHECKED: Gary Kang	
	UNIT: mm	SCALE: A4 5:4	FINISH:	APPROVED: George Yang
	THIRD ANGLE PROJECTION TOLERANCE: Angle: ± 1° X. ± 0.25 .X ± 0.20 .XX ± 0.15		MATERIAL: RoHS Compliant	DATE: 04/25/2022
		DRAWN: Ting		

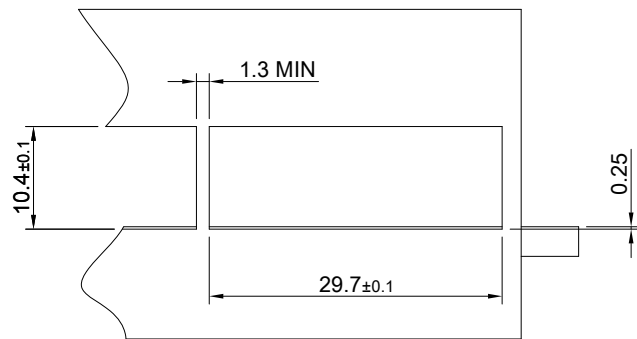

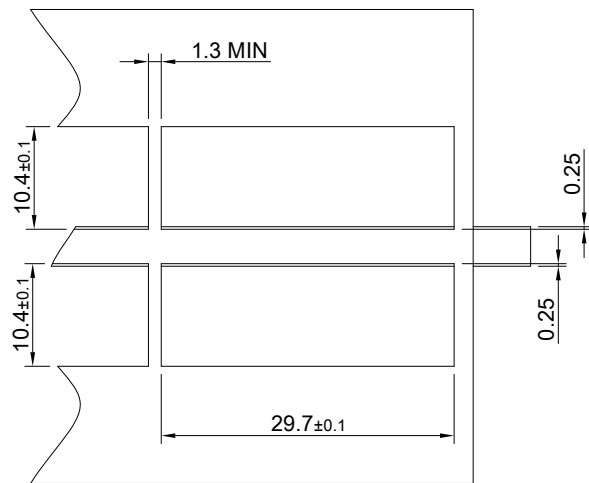

RECOMMENDED BEZEL CUT-OUT

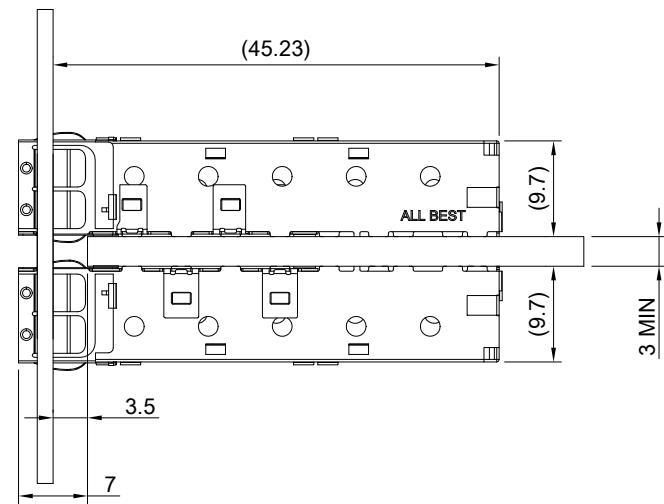
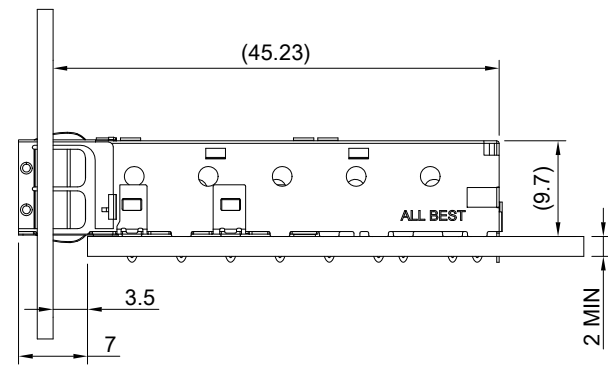

RECOMMENDED BEZEL CUT-OUT FOR BELLY TO BELLY MOUNTING



 <p>ALL BEST ELECTRONICS CO., LTD.</p>	TITLE: SFP+ 1X2 Cage Assembly		SHEET: 2/4	REV. D
	DWG#: R-SH-008040-6-F-19		CHECKED: Gary Kang	
	UNIT: mm	SCALE: A4 5:4	FINISH:	APPROVED: George Yang
	 THIRD ANGLE PROJECTION TOLERANCE: Angle: ± 1° X ± 0.15 .X ± 0.10 .XX ± 0.05		MATERIAL: RoHS Compliant	DATE: 04/25/2022
		DRAWN: Ting		

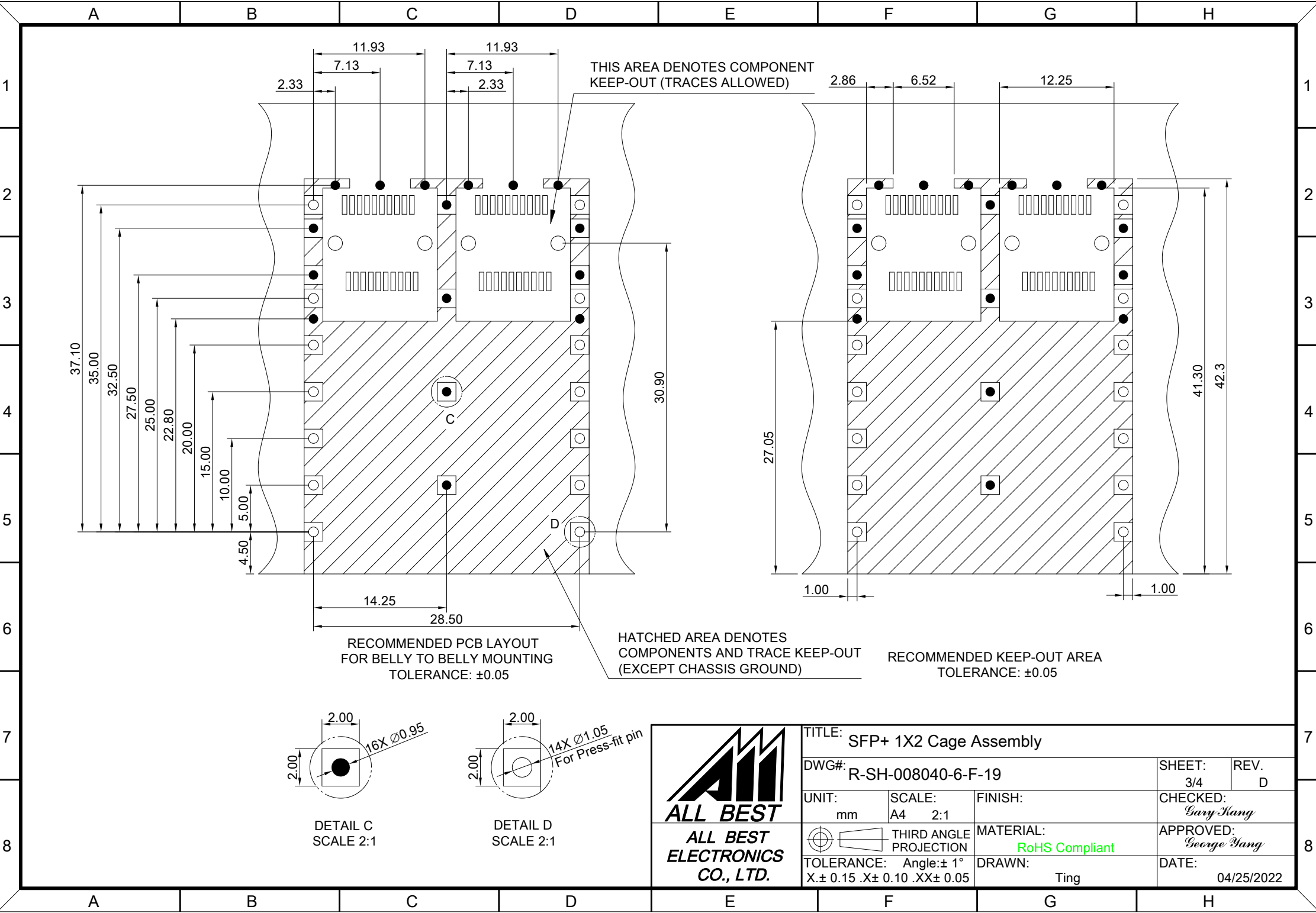

TITLE: SFP+ 1X2 Cage Assembly			SHEET: 3/4	REV. D
DWG#: R-SH-008040-6-F-19			CHECKED: Gary Kang	
UNIT: mm	SCALE: A4 2:1	FINISH:	APPROVED: George Yang	
THIRD ANGLE PROJECTION		MATERIAL: RoHS Compliant	DATE: 04/25/2022	
TOLERANCE: Angle: ± 1° X: ± 0.15 .X: ± 0.10 .XX: ± 0.05		DRAWN: Ting		

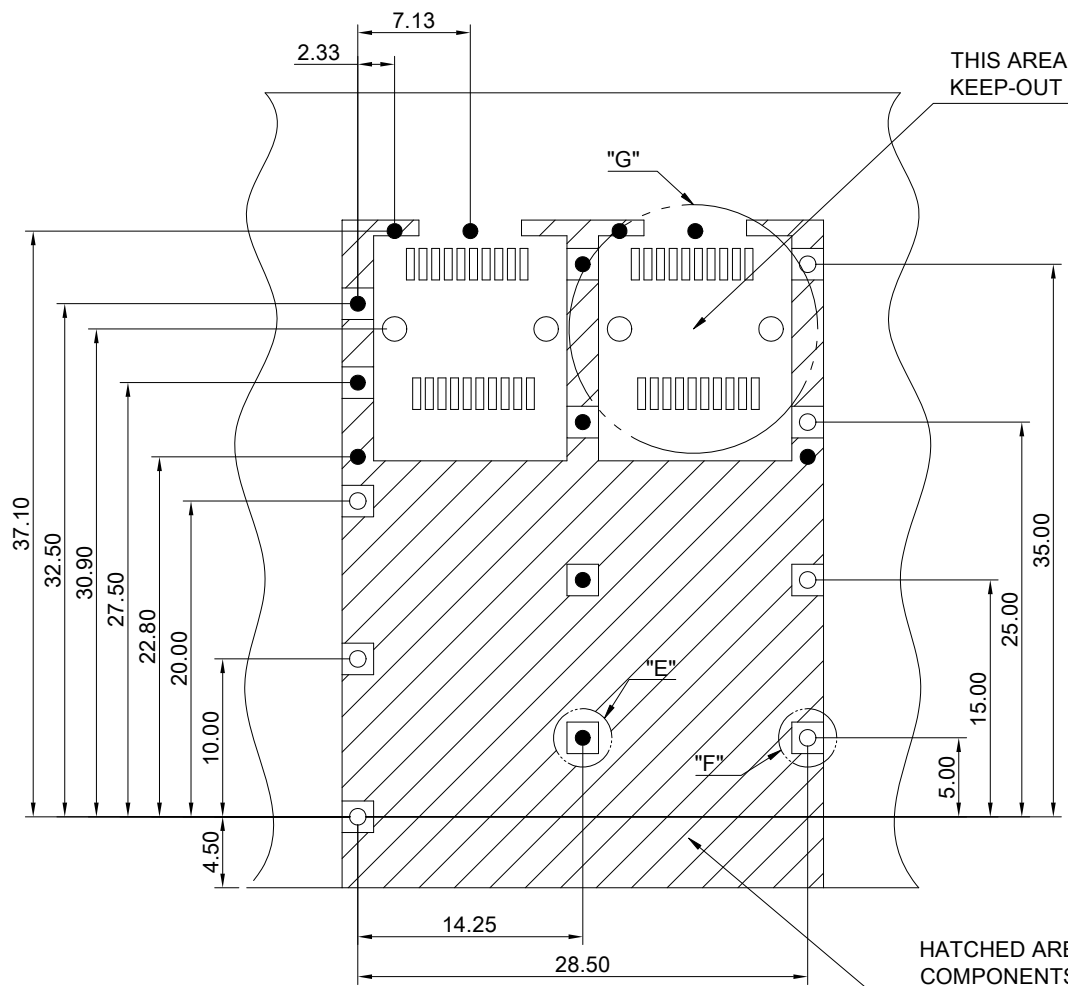

THIS AREA DENOTES COMPONENT KEEP-OUT (TRACES ALLOWED)

HATCHED AREA DENOTES COMPONENTS AND TRACE KEEP-OUT (EXCEPT CHASSIS GROUND)

RECOMMENDED PCB LAYOUT TOLERANCE: ± 0.05

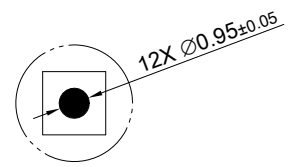

DETAIL E SCALE 2:1

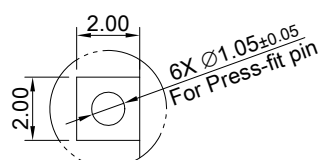

DETAIL F SCALE 2:1

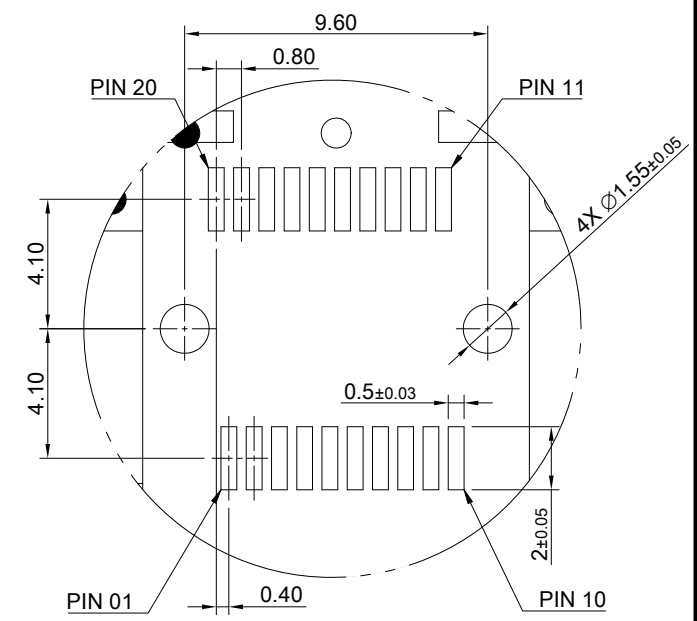

DETAIL G SCALE 2:1



ALL BEST ELECTRONICS CO., LTD.

TITLE: SFP+ 1X2 Cage Assembly			
DWG#: R-SH-008040-6-F-19			SHEET: 4/4
			REV. D
UNIT: mm	SCALE: A4 2:1	FINISH:	
THIRD ANGLE PROJECTION		MATERIAL: RoHS Compliant	
TOLERANCE: Angle: $\pm 1^\circ$ X. ± 0.15 .X ± 0.10 .XX ± 0.05		DRAWN: Ting	APPROVED: George Yang
			DATE: 04/25/2022