

DETAIL A
SCALE 5:1

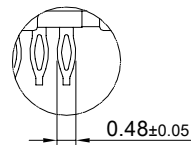

DETAIL B
SCALE 5:1

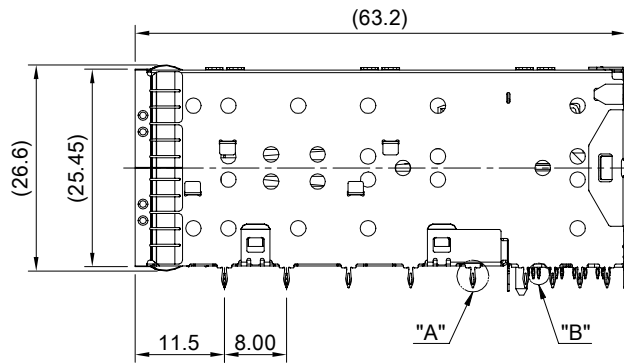
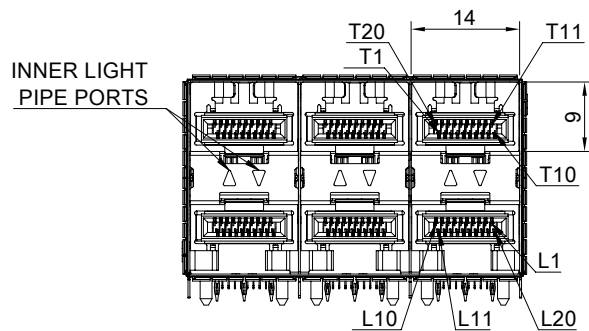
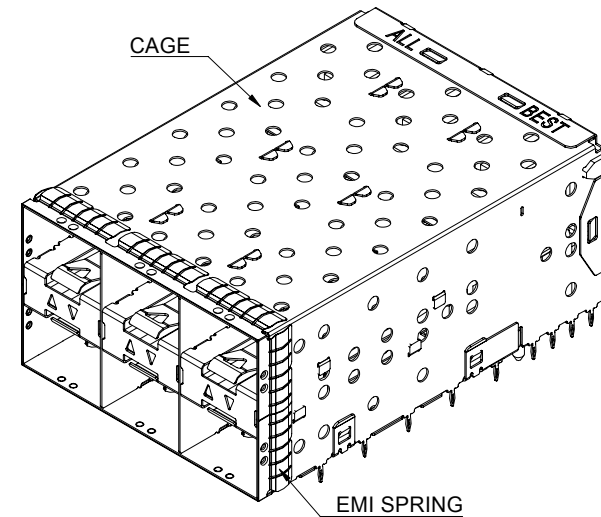

MATERIAL
 CAGE: NICKEL SILVER
 CONNECTOR HOUSING: THERMOPLASTIC, UL 94V-0
 CONNECTOR HOUSING SHIELD: STAINLESS STEEL
 CONTACTS: COPPER ALLOY
 EMI SPRING: STAINLESS STEEL
 LIGHT PIPE: PC (CLEAR)

FINISH
 CONTACT: 15µ" MIN. GOLD ON MATING END;
 30µ" MIN. MATTE TIN ON TERMINATION END;
 ALL UNDERPLATED 50µ" MIN. NICKEL

ELECTRICAL CHARACTERISTICS
 CONTACT CURRENT RATING: 0.5 AMPERE
 DIELECTRIC WITHSTANDING VOLTAGE: 300 VAC
 VOLTAGE RATING: 30 VAC
 CONTACT RESISTANCE: 80 mΩ MAX.

THIS PRINT IS
PRELIMINARY
 UNQUALIFIED PRODUCT
 CONTACT PRODUCT ENGINEERING
 BEFORE USING THIS PRINT



TITLE: Stacked SFP28 2X3 ASS'Y w/ Light Pipe			
DWG#: R-OP-0092X3-P-F-N3-01-IN		SHEET: 1/2	REV. REF
UNIT: mm	SCALE: A4 1:1	CHECKED:	
THIRD ANGLE PROJECTION		APPROVED:	
TOLERANCE: Angle: ± 1°		MATERIAL: RoHS Compliant	DATE: 03/26/2024
X.± 0.25 .X± 0.20 .XX± 0.15		DRAWN: Tony	

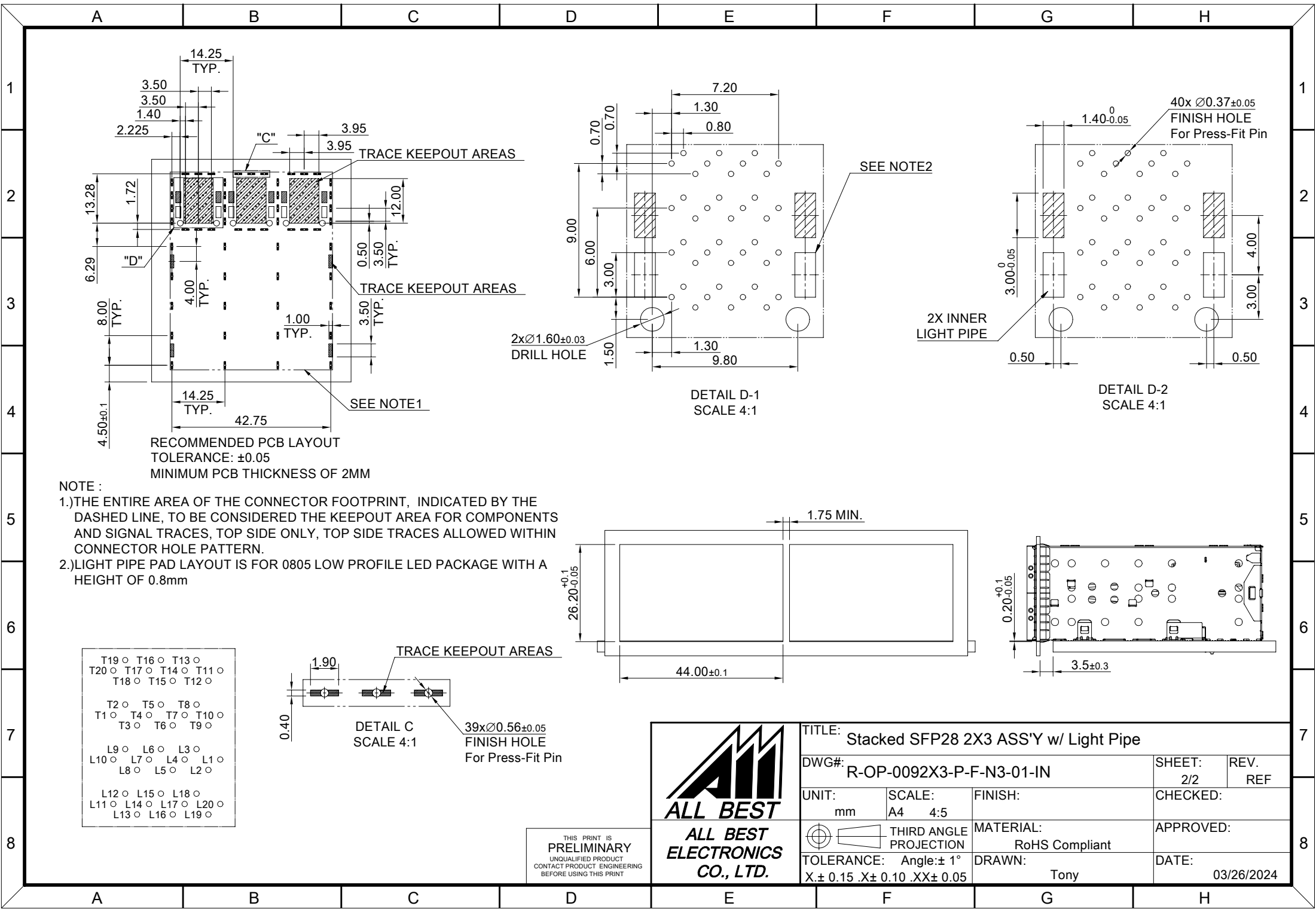

RECOMMENDED PCB LAYOUT
TOLERANCE: ±0.05
MINIMUM PCB THICKNESS OF 2MM

- NOTE :
- 1.)THE ENTIRE AREA OF THE CONNECTOR FOOTPRINT, INDICATED BY THE DASHED LINE, TO BE CONSIDERED THE KEEPOUT AREA FOR COMPONENTS AND SIGNAL TRACES, TOP SIDE ONLY, TOP SIDE TRACES ALLOWED WITHIN CONNECTOR HOLE PATTERN.
 - 2.)LIGHT PIPE PAD LAYOUT IS FOR 0805 LOW PROFILE LED PACKAGE WITH A HEIGHT OF 0.8mm

- T19 ○ T16 ○ T13 ○
- T20 ○ T17 ○ T14 ○ T11 ○
- T18 ○ T15 ○ T12 ○

- T2 ○ T5 ○ T8 ○
- T1 ○ T4 ○ T7 ○ T10 ○
- T3 ○ T6 ○ T9 ○

- L9 ○ L6 ○ L3 ○
- L10 ○ L7 ○ L4 ○ L1 ○
- L8 ○ L5 ○ L2 ○

- L12 ○ L15 ○ L18 ○
- L11 ○ L14 ○ L17 ○ L20 ○
- L13 ○ L16 ○ L19 ○

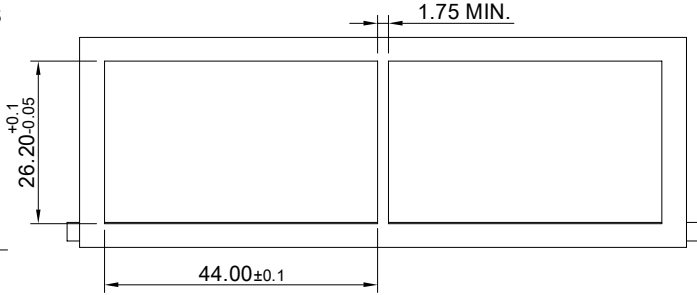
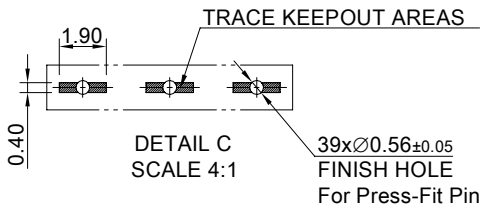

THIS PRINT IS
PRELIMINARY
UNQUALIFIED PRODUCT
CONTACT PRODUCT ENGINEERING
BEFORE USING THIS PRINT



TITLE: Stacked SFP28 2X3 ASS'Y w/ Light Pipe			
DWG#: R-OP-0092X3-P-F-N3-01-IN		SHEET: 2/2	REV. REF
UNIT: mm	SCALE: A4 4:5	CHECKED:	
THIRD ANGLE PROJECTION		APPROVED:	
TOLERANCE: Angle: ± 1°		DATE: 03/26/2024	
X.± 0.15 .X± 0.10 .XX± 0.05		DRAWN: Tony	