

MATERIAL
 CAGE: NICKEL SILVER
 EMI SPRING: STAINLESS STEEL
 HEAT SINK: COPPER ALLOY
 HEAT SINK CLIP: STAINLESS STEEL

FINISH
 HEAT SINK: NICKEL OVER COPPER

NOTE
 ▲ DIMENSION APPLIES WITH MODULE INSERTED IN CAGE

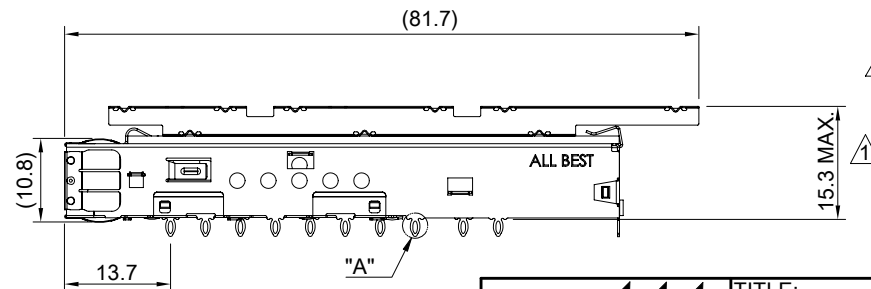
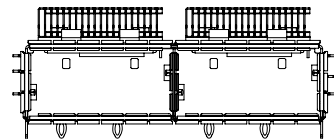

THIS PRINT IS
PRELIMINARY
 UNQUALIFIED PRODUCT
 CONTACT PRODUCT ENGINEERING
 BEFORE USING THIS PRINT



TITLE: QSFP-DD 1X2 Cage Assembly w/ Heat Sink			
DWG#: H-OR-QD2-4CMFA4-TK		SHEET: 1/4	REV. REF.
UNIT: mm	SCALE: A4 1:1	CHECKED:	
THIRD ANGLE PROJECTION		APPROVED:	
TOLERANCE: Angle: ± 1°		MATERIAL: RoHS Compliant	DATE: 03/22/2024
X: ± 0.25 .X: ± 0.20 .XX: ± 0.15		DRAWN: Jason Zhao	

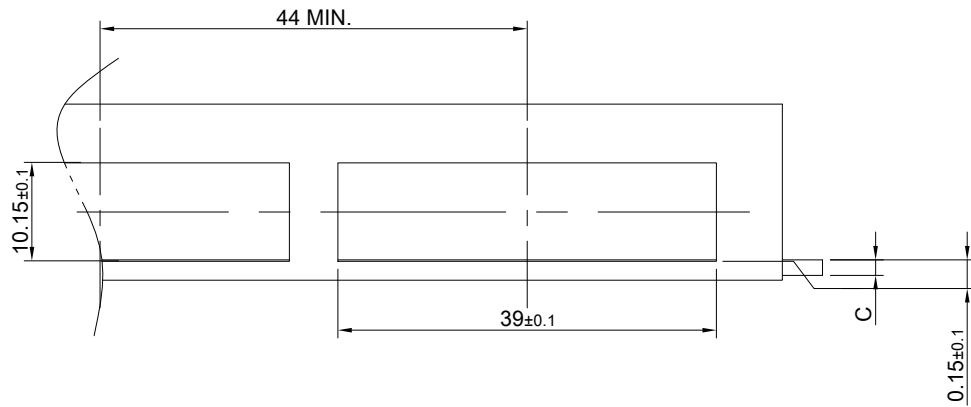

SINGLE-SIDE CONFIGURATION

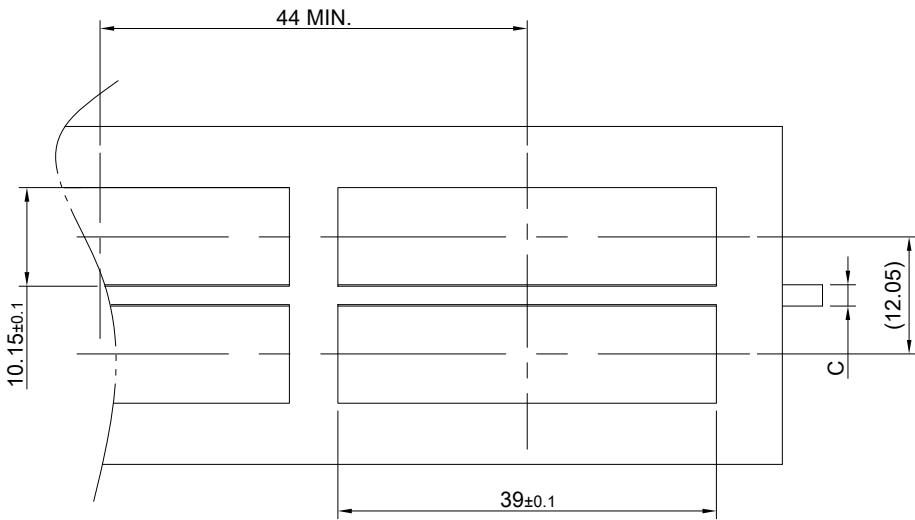
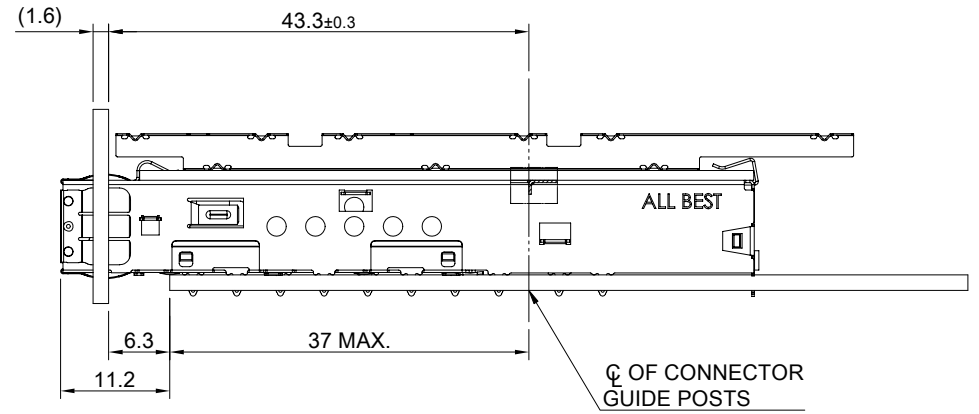

BELLY TO BELLY CONFIGURATION

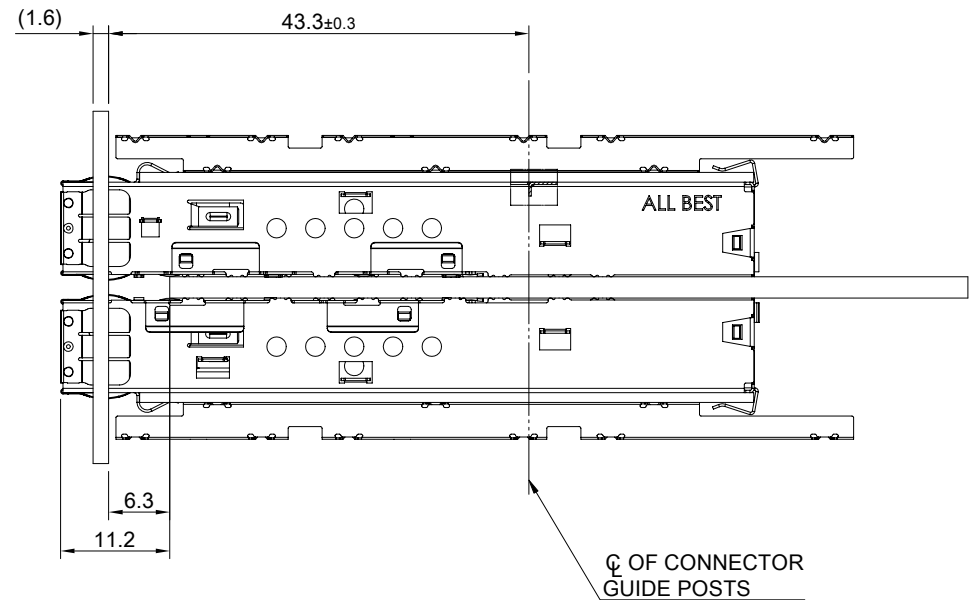

C = THICKNESS OF PC BOARD
 SINGLE-SIDE = 1.6MM (MIN.)
 BELLY TO BELLY = 2.2MM (MIN.)

THIS PRINT IS
PRELIMINARY
 UNQUALIFIED PRODUCT
 CONTACT PRODUCT ENGINEERING
 BEFORE USING THIS PRINT



TITLE: QSFP-DD 1X2 Cage Assembly w/ Heat Sink			
DWG#: H-OR-QD2-4CMFA4-TK		SHEET: 2/4	REV. REF.
UNIT: mm	SCALE: A4 5:4	FINISH:	CHECKED:
TOLERANCE: Angle: ± 1° X ± 0.15 .X ± 0.10 .XX ± 0.05		MATERIAL: RoHS Compliant	APPROVED:
THIRD ANGLE PROJECTION		DRAWN: Jason Zhao	DATE: 03/22/2024

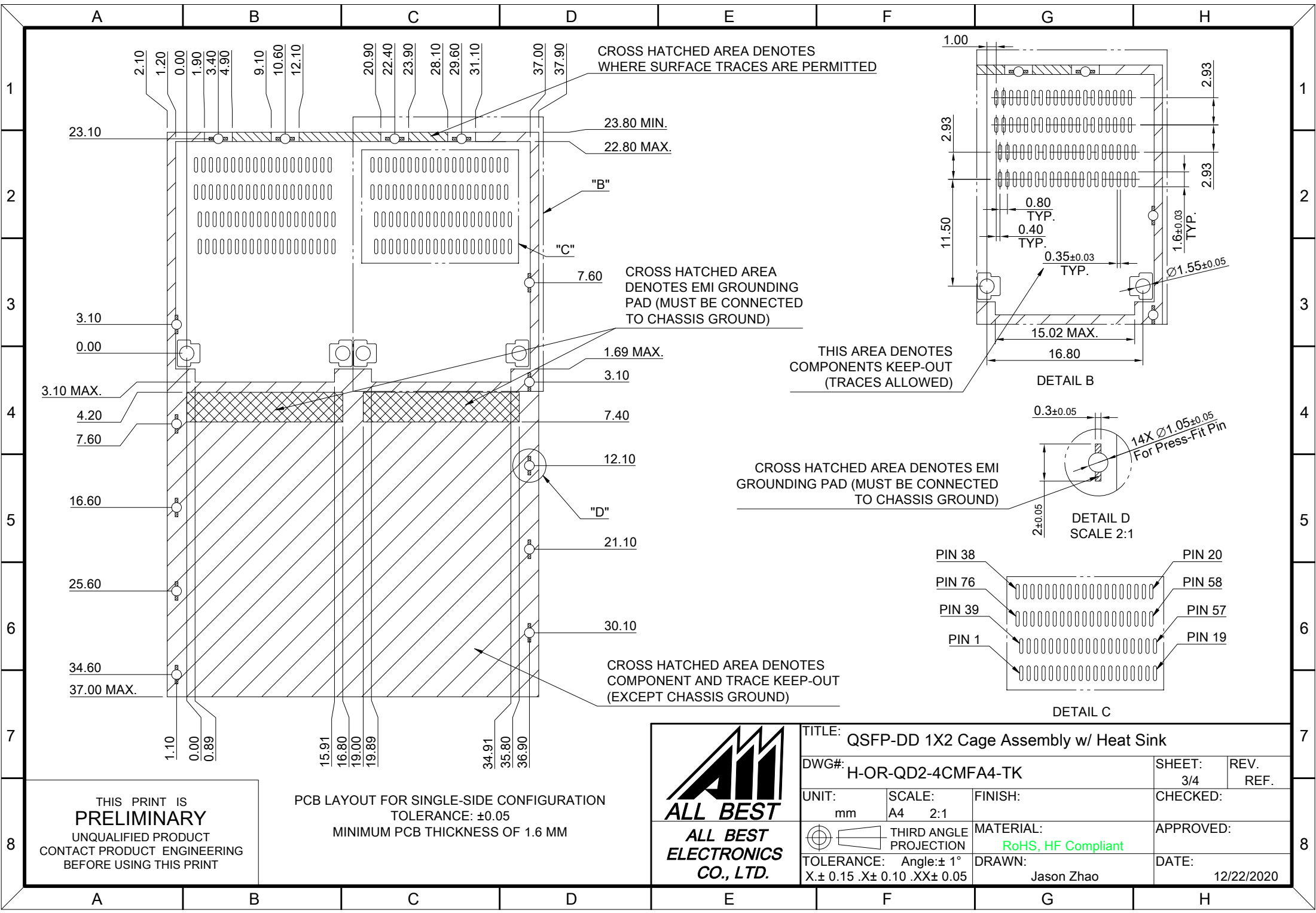

THIS PRINT IS
PRELIMINARY
 UNQUALIFIED PRODUCT
 CONTACT PRODUCT ENGINEERING
 BEFORE USING THIS PRINT

PCB LAYOUT FOR SINGLE-SIDE CONFIGURATION
 TOLERANCE: ±0.05
 MINIMUM PCB THICKNESS OF 1.6 MM



TITLE: QSFP-DD 1X2 Cage Assembly w/ Heat Sink			
DWG#: H-OR-QD2-4CMFA4-TK		SHEET: 3/4	REV. REF.
UNIT: mm	SCALE: A4 2:1	CHECKED:	
THIRD ANGLE PROJECTION		APPROVED:	
TOLERANCE: Angle: ±1° X ± 0.15 .X ± 0.10 .XX ± 0.05		MATERIAL: RoHS, HF Compliant	DATE: 12/22/2020
		DRAWN: Jason Zhao	

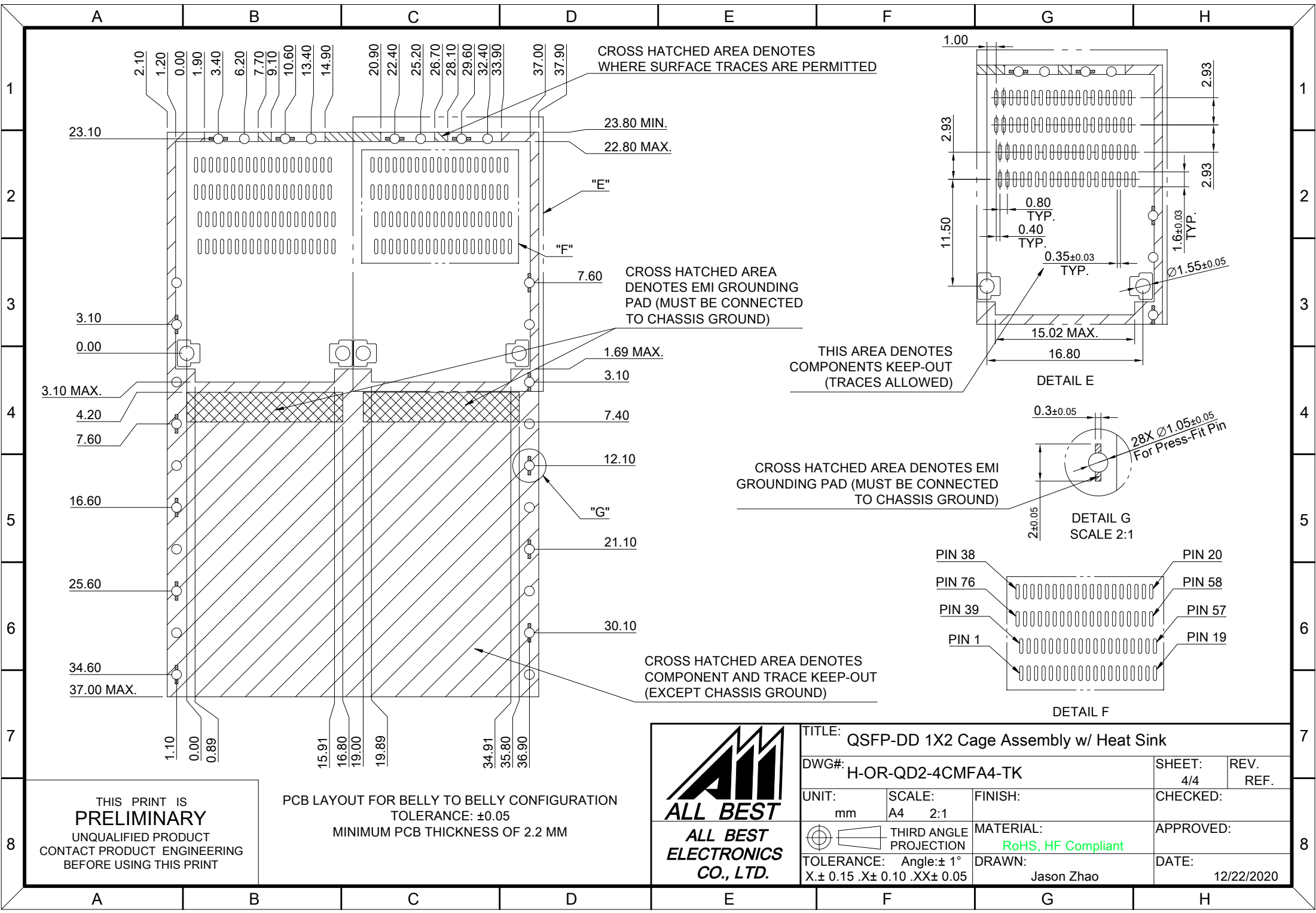

THIS PRINT IS
PRELIMINARY
UNQUALIFIED PRODUCT
CONTACT PRODUCT ENGINEERING
BEFORE USING THIS PRINT

PCB LAYOUT FOR BELLY TO BELLY CONFIGURATION
TOLERANCE: ± 0.05
MINIMUM PCB THICKNESS OF 2.2 MM



TITLE: QSFP-DD 1X2 Cage Assembly w/ Heat Sink			
DWG#: H-OR-QD2-4CMFA4-TK		SHEET: 4/4	REV. REF.
UNIT: mm	SCALE: A4 2:1	CHECKED:	
THIRD ANGLE PROJECTION		APPROVED:	
TOLERANCE: Angle: $\pm 1^\circ$ X: ± 0.15 .X: ± 0.10 .XX: ± 0.05		MATERIAL: RoHS, HF Compliant	DATE: 12/22/2020
		DRAWN: Jason Zhao	

